

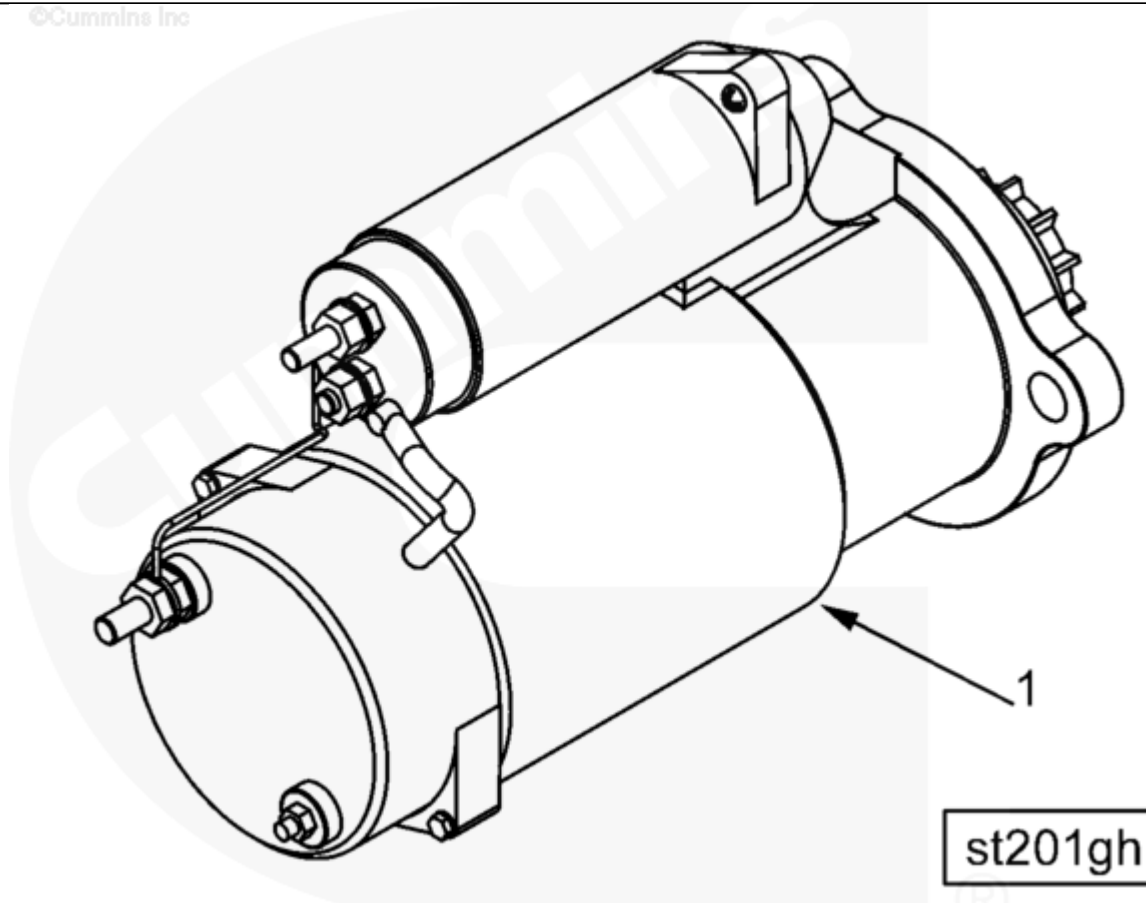

Parts Catalog - Option Detail

Electronic Parts Catalog - Option Detail				
Option	Group	Graphic	Film Card	Date
ST2025-09	13.05	st201gh	II	07-FEB-05
Engines	ISM CM570, ISM CM570/870, ISM CM875, ISM CM876, ISM CM876 E, ISM11 CM876 M103, ISM11 CM876 SN, M11 CELECT, M11 CELECT PLUS, M11 MECHANICAL, QSM11 CM570, QSM11 CM876			

©Cummins Inc



[SMALL](#) | [MEDIUM](#) | [LARGE](#)

Cart	Ref No	Part Number	Part Description	Required	Remarks
View My Cart					
		ST2025-09	Starting Motor		
					Starting Motor
					Manufacturer: Delco Remy
					Model: 39 MT-HD
					Voltage: 12

					Rotation: Right Hand
					Solenoid Angle (degrees): 82
					Length: 360.0mm (14.17 in.)
					Power Supply: Electric
					Cummins Branded: Yes
					Ground Wire Included: No
<input type="checkbox"/>	1	3103915	Starting Motor	1	

© 2019 Cummins Inc., Box 3005, Columbus, IN 47202-3005 U.S.A.
 Terms of Use and Disclaimers | Recommended System Requirements
 Need Assistance? Please click on the Contact Us button in the top right corner of any page.